



RKT-3386

SQUARE TRIMMING POTENTIOMETER

FEATURES

- Single Turn/ Cermet/ Industrial/ Sealed
- Many Terminal Styles

Electrical Characteristics	
Standard Resistance Range	10Ω - 5MΩ
Resistance Tolerance	±10% ; ±20% for 10 ohm
Absolute Minimum Resistance	≤10Ω (100Ω ≤ R ≤ 1KΩ)
Contact Resistance Variation	CRV ≤ 3%R or 5Ω (whichever is larger)
Insulation Resistance	RI ≥ 1GΩ(100Vac)
Withstand Voltage	220VDC
Effective Travel	300° ± 10°

Environmental Characteristics	
Power Rating (315volts max)	0.5W@70°C, 0W@125°C
Temperature Range	-55°C ~ +125°C
Temperature Coefficient	200 or ±100ppm/°C
Temperature Variation	-55°C, 30min, +125°C 30min, 5 cycles ΔR ≤ 5%R, Δ(Uab/Uac) ≤ 10%
Collision	100m/s ² , 4000cycles, ΔR ≤ 2%R
Electrical Endurance at 70°C	0.5W@70°C, 1000h ΔR ≤ 10%R Δ(Uab/Uac) ≤ 10%, CRV ≤ 3% or 5Ω (whichever is larger)
Rotational Life	200 cycles ΔTR ≤ 10%R, CRV ≤ 3% or 5Ω (whichever is larger)

Physical Characteristics	
Starting Torque	≤ 35mN·m
Marking	Resistance Tolerance (When no identification, it is of ± 10%) Resistance Code, Model
Standard Packaging	50pcs, per tube

Common Dimensions

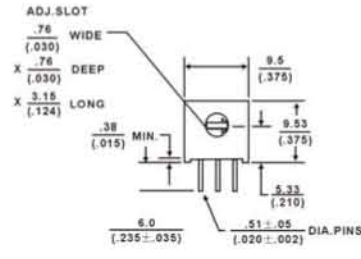

RKT-3386F

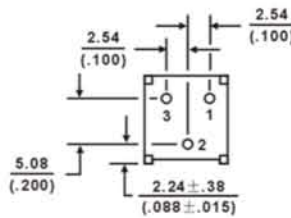

RKT-3386H

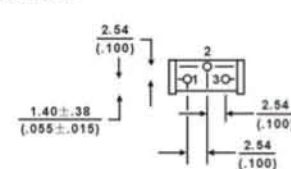

RKT-3386J

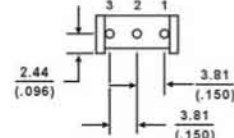

RKT-3386S

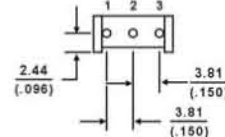

RKT-3386W

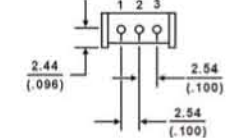

RKT-3386X

How to Order

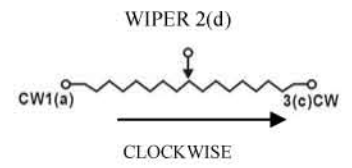
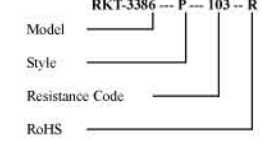

Tolerance is ±0.25 if no identification

Resistance Table

Resistance(Ohms)	Resistance Code
10	100
20	200
50	500
100	101
150	151
200	201
250	251
300	301
470	471
500	501
680	681
1,000	102
1,500	152
2,000	202
2,200	222
2,500	252
3,000	302
4,700	472
5,000	502
6,800	682
10,000	103
15,000	153
20,000	203
22,000	223
25,000	253
30,000	303
33,000	333
47,000	473
50,000	503
68,000	683
100,000	104
150,000	154
200,000	204
220,000	224
250,000	254
300,000	304
330,000	334
470,000	474
500,000	504
680,000	684
1,000,000	105
2,000,000	205
2,200,000	225
5,000,000	505

RKT-3386B

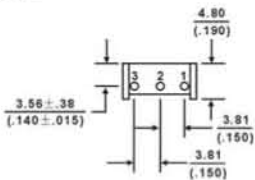

RKT-3386C

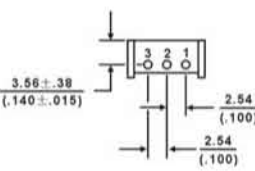

Common Dimensions

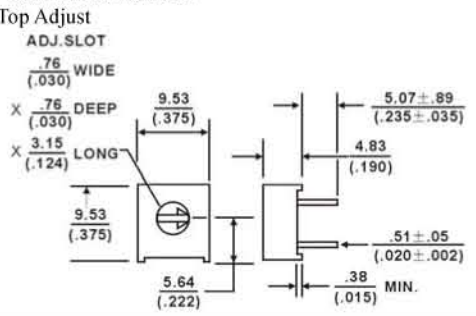

RKT -3386T

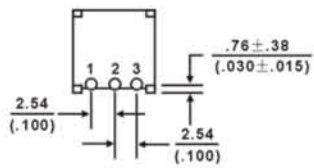

RKT -3386U

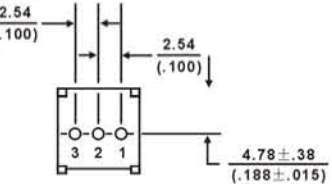

RKT-3386Y

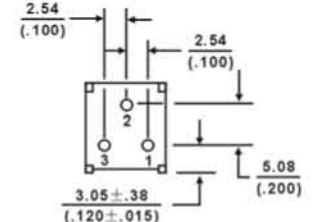

RKT -3386G

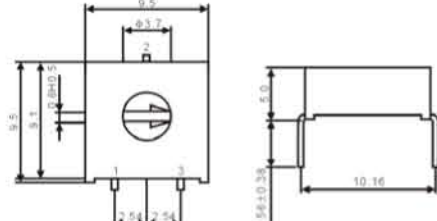

RKT -3386(STYLE) -EY5-(RESISTANCE CODE)

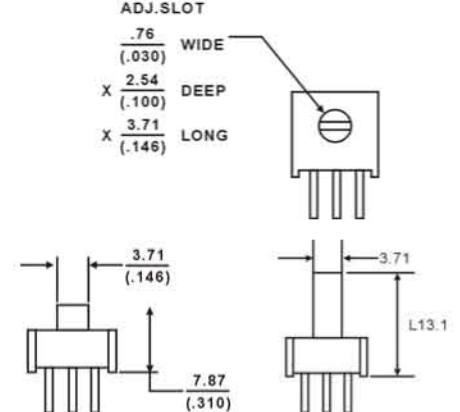

RKT -3386(STYLE)-EY5-(RESISTANCE CODE)-T

The Model 3386 is available with a knob for finger adjustment. Add suffix letter "T" to order code.

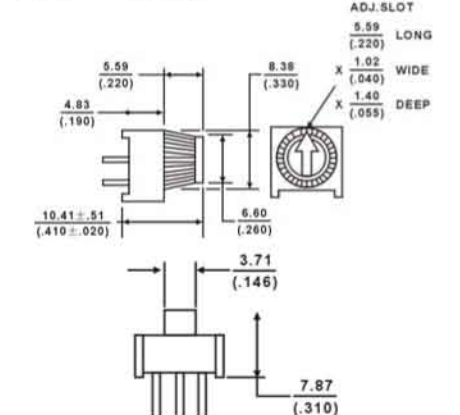

RKT -3386K

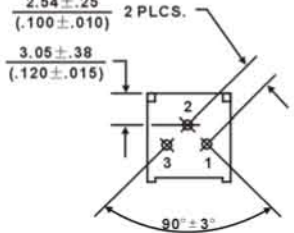

RKT -3386M

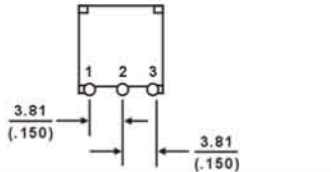

RKT -3386P

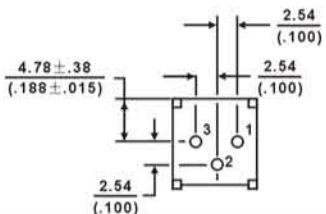

RKT -3386R

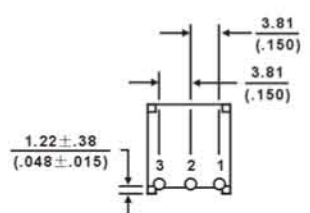

RKT -3386V

